

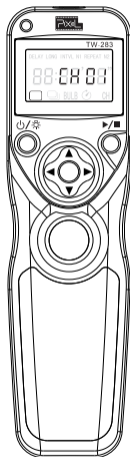

Wireless Timer Remote Control TW-283



User Manual



Overview

First, thanks for choosing PIXEL high-performance wireless timer remote control TW-283. It features simple single shooting, continuous shooting, [BULB] shooting, delay shooting and timer schedule shooting. With low power consumption LCD screen, it makes your shooting plan clear and more convenient to use delay shooting and timer schedule shooting.

Before using this product, you must read the manual and fully understand how to use it and ensure that you can easily handle the operation method and also use it properly.

Precautions

- △ Make sure the batteries are installed correctly, or it may lead to leak, overheat or crack.
- △ Before attaching Receiver (TW-283RX), please make sure the camera and Receiver are powered-on.
- △ When connecting power line and the device, please do not pull and drag.
- △ This product involved in electronic product accessories which may cause the failure to use of this device. But this possibility is very low.
- △ Do not put this product in strong vibration, or it may cause fault of this product.
- △ Power off the device and remove the batteries during long periods of non-use.
- △ Do not expose this product in high temperature locations, such as confined car exposed to strong direct sunlight, control panel and other overheating places.
- △ Keep it dry. Do not touch this product with wet hand. Do not expose this product to water or rain, or you may not be able to use it.

- ⚠ Do not use it inflammables gas, or it may cause explosion or fire.
- ⚠ This product involved in battery. Please strictly follow the corresponding operations related to battery, or it may cause explosion or fire.

TW-283 Introduction

- Adopting wireless remote control technology, it can control camera to shoot remotely by external shutter socket.
- Using FSK module, its reliability and stability are improved. The application of 2.4GHz global free frequency range enables 30 channels for options.
- The remote control distance can up to 80M.
- LCD screen displays channel, battery level and function mode which is easy to comprehend and simple to handle.
- Ultra-low power consumption under stand-by mode. The powered by AAA batteries.
- Interchangeable connecting cable for different brand's camera models.
- Supports simple single shooting, continuous shooting, [BULB] shooting, delay shooting and timer schedule shooting.
- Available to set timer schedule shooting by setting related parameters.



Item Included

After opened the package, please check the below items are included. If any accessory shown as below is Not included, please contact the dealer.

1. Transmitter (TW-283TX)-----1 pc
2. Receiver (TW-283RX)-----1pc
3. Shutter connecting cable---- 1pcs
4. User manual----1 pc

Name of Each Part:

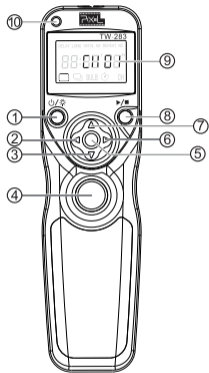

TW-283 Transmitter

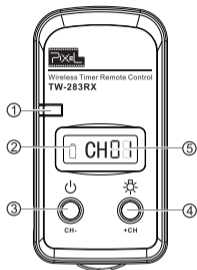
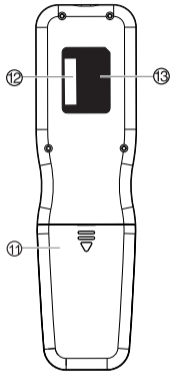

TW-283 Receiver

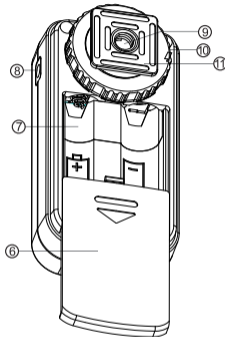

Transmitter(TW-283TX)

- ① Power ON/OFF/Backlit Button
- ② Shift Left Button
- ③ Number Reduce Button
- ④ Release Button
- ⑤ Set/Confirm Button
- ⑥ Shift Right Button
- ⑦ Number Add Button
- ⑧ Timer Schedule Start/Stop Button
- ⑨ Display Screen
- ⑩ LED Light Indicator
- ⑪ Battery Cover
- ⑫ Serial No.
- ⑬ Product Back Sticker

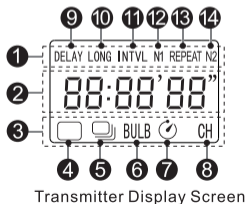

Receiver(TW-283RX)

- ① LED Light Indicator
- ② Low Battery Icon
- ③ Power Switch/ Channel Reduce Button
- ④ Backlit Button/Channel Add Button
- ⑤ Channel Display Screen
- ⑥ Battery Compartment Cover
- ⑦ Battery Tray
- ⑧ Signal Control Output Port
- ⑨ Quick-Release Shoe Hold-Down Nut
- ⑩ Hot Shoe Lock Nut
- ⑪ Hot Shoe Fixed Mount

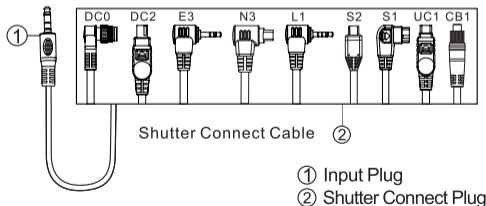

Transmitter Display Screen

- ① Timer Schedule Function Zone
- ② Time Display Zone
- ③ Function Zone
- ④ Single Shooting Icon
- ⑤ Continuous Shooting Icon
- ⑥ BULB Shooting Icon
- ⑦ Delay Shooting Icon
- ⑧ Communication Channel Icon
- ⑨ Timer Schedule Delay Icon
- ⑩ Timer Schedule Exposure Time Icon
- ⑪ Timer Shooting Interval Time Icon
- ⑫ Timer Shooting Numbers Icon
- ⑬ Repeat Timer Schedule Interval Time Icon
- ⑭ Repeat Timer Schedule Times Icon

Device installation and Usage

Before using, you must read your camera user manual carefully and understand camera operation methods and function settings. Because camera function settings may affect the effective control of this device over your camera.



Install and Change Batteries

When is in low battery, the letters on the display screen darkens or the low battery icon [] blinks, it shows that the battery voltage is lowered to the level that may affect its performance. Please ready spare batteries. The Transmitter is powered by AAA batteries.

1. Please Install batteries correctly to the compartment according to the + and – terminal of the batteries.

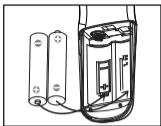

TW-283 Transmitter

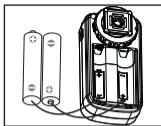

TW-283 Receiver

⚠ When installing batteries, please note the terminal of the batteries. Faulty operation will cause the fault of this device, or even damaged to the device or personnel injury.



Connect Receiver to Camera

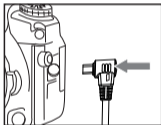
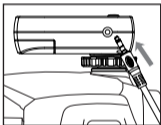

1. Make sure the Receiver is installed in the right place. And the camera and Receiver are powered-on.
2. First, please insert the input socket of the shutter connecting cable to the signal control output socket of the Receiver. Please make sure the cable is inserted to the end.
 - The remote control may not be able to control the camera if the connecting cable is NOT inserted to the end.

3. Mount the camera on the tripod or other mounting bracket. Open the protective cover of your camera external shutter socket, and then insert shutter socket to camera external shutter socket in the right place. Please lock the nut if available.
 - The external shutter socket of most cameras have misplug-proof gap. When inserting the socket, please note the direction to avoid the damage of camera external shutter socket.
4. Turn on the Receiver and your camera.



Power ON/OFF

◆ TW-283 Transmitter

1. Power On/Off Transmitter(TW-283TX). Press power button for [/] 2sec to turn on the Transmitter.
2. After powered-on, the timer scedule and communicationchannle that have been set remain in effect
3. The Transmitter stand-by time is 30 mins. If no operations performed after 30 mins, the Transmitter will turn off automatically.

◆ TW-283 Receiver

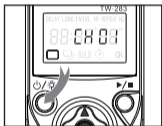

TW-283 Transmitter

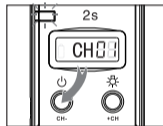

TW-283 Receiver

1. Press power button[]for 2 set to turn on the Receiver, at this time, the LED light indicator will blink green light every 2 sec. The communication channel is displayed on screen.
2. After powered-on, the communication channel that has been set before remains in effect.

3. The Receiver will not turn on or off automatically. When power is ON, press the power button for 2 sec to turn off the Receiver.



Channel Setting

◆ Set Transmitter Communication Channel (TW-283TX)

1. Press Shift Left Button [◀] or Shift Right Button [▶] to move the Transmitter function icon to channel [CH] icon.
2. Press Set/Confirm Button to enter channel setting. At this time, channel number will blink .
3. Adjust channel numbers by pressing number add button [▲] or Number Reduce Button [▼].
4. Repress Set/Confirm Button to save current channel setting.
Set Receiver Communication Channel (TW-283RX)

1. Turn on the power, the communication channel is shown as you have been set before by default.
2. Press [+CH] and [CH-] button at the same time to enter channel setting. The channel icon [CH] on the display screen will blink.
3. Press [+CH] to add 1 channel and [CH-] to reduce 1 channel.
4. Repress [+CH] and [CH-] button at the same time or if no operation performed for 10 sec to save and exit.



TW-283 Transmitter

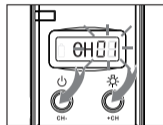

TW-283 Receiver

*For effective control, the Transmitter and Receiver must set to the same channel.



Turn on Backlit

- ◆ Transmitter (TW-283TX)
Gently press [⏻/☀] button to turn on LCD screen backlit.
- ◆ Receiver (TW-283RX)
When power is ON, press and hold backlit button [☀] for 2 set to turn on the backlit.

- After opened the backlit, it will light up all the time if the operation interval time between two buttons operations is within 6 sec.
- The backlit will not turn on or turn off manually. It will be turned off automatically if no any operations performed for 6 sec.

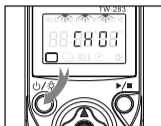

TW-283 Transmitter

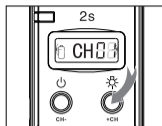

TW-283 Receiver



Shooting Control

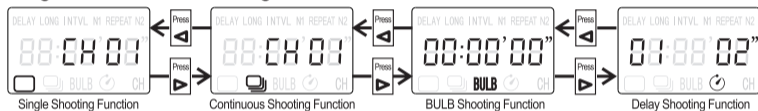

Shooting Function Select Diagram:



The below usage introduction is based on the operation when the Receiver and camera are connected properly and powered-on. The shooting function introduction see below.





Single Shooting

1. When power is ON, move Transmitter function icon to single shooting icon [] by pressing shift left button [] or shift right button [].
2. Half-press release button, the Transmitter will send focus signal. The green LED light indicator on the Transmitter and Receiver will light up, and the camera is in focusing status until you release or full-press the button.

3. Full-press release button, the Transmitter will send shooting signal. The red LED light indicator on the Transmitter and Receiver will light up for a moment. The camera is shooting.
 - Please set camera function setting as [].
 - When camera function setting is [], it may shoot continuously.
 - When camera function setting is [**BULB**], camera will shoot with Bulb function. It may cause underexposure or overexposure.
 - When camera function setting is [], camera will delay shooting.



Continuous Shooting

1. When power is ON, move Transmitter function icon to continuous shooting icon [] by pressing shift left button [] or shift right button [].
2. Half-press release button, the Transmitter will send focus signal. The green LED light indicator on the Transmitter and Receiver will light up, and the camera is in focusing status until you release or full-press the button.
3. Full-press release button, the red LED light indicator on the Transmitter and Receiver will light up. Full-press and hold this button, the Transmitter will send shooting signal continuously. The red LED light indicators on both of the Transmitter and Receiver will light up steadily. Camera will start continuous shooting.
4. Release the release button, the Transmitter will stop sending signal. Camera will stop shooting.
 - Set camera function setting as []
 - When camera function setting is [], it may starts single shooting.
 - When camera function setting is [**BULB**], camera will shoot with Bulb function. It may cause underexposure or overexposure.

- When camera function setting is [], camera will perform one time or many times delay shooting.



BULB Shooting

1. When power is ON, move Transmitter function icon to BULB shooting icon [**BULB**] by pressing shift left button [] or shift right button [].
 2. Half-press release button, the Transmitter will send focus signal. The green LED light indicator on the Transmitter and Receiver will light up, and the camera is in focusing status until you release or full-press the button.
 3. Full-press and hold this button, the Transmitter will send BULB signal. The red LED light indicator starts to blink and time. The red LED light indicator lights up steadily, the Receiver outputs shooting signal continuously. The camera starts to continuous exposure shooting.
 4. Re-press release button, the Transmitter outputs BULB shooting end signal and exposure time will be displayed. And then camera will stop exposure shooting.
- Set camera function setting as [**BULB**]
 - When camera function setting is [], camera will shoot only once and won't perform BULB shooting.
 - When camera function setting is [], camera will shoot continuously.
 - When camera function setting is [], camera will perform delay shooting once.















Delay Shooting

TW-283 delay shooting function is applied to set custom delay time and number of shots.



- ◆ Delay Shooting Setting





1. When power is ON, move Transmitter function icon to delay shooting icon [] by pressing shift left button [] or shift right button []. Press SET button to enter delay shooting time setting. Shooting time value [02] blinks, press [] to add delay time and press [] button to reduce delay time. You can set shooting time between 1-59sec.
2. Press [] button to enter the number of shots setting of delay shooting. This number of shots [02] blinks, press [] to add number of shots and press [] button to reduce number of shots. You can set number of shots as 1-59 pictures.
3. After setting the parameters, press SET button to save the parameters and exit.

- After entering delay shooting setting, the Transmitter will save the setting parameters that you set last time.
- By pressing shift left button [] or shift right button [], you can switch between number of shots and delay time.
- Gently press [] button once, setting value will be added one, press and hold this button, the setting value will be added quickly; Gently press [] once, setting value will be reduced one, press and hold this button, setting value will be reduced quickly.

◆ Delay Shooting Operation





1. Move Transmitter function icon to delay icon [] by pressing shift left button [] or shift right button []
2. Half-press release button, the Transmitter will send focus signal. The green LED light indicator on the Transmitter and Receiver will light up, and the camera is in focusing status until you release or full-press the button.
3. Full-press release button, the Transmitter will send all shooting information to the Receiver. The Transmitter starts to delay count down, and the red LED light indicator on the Receiver

- will blink quickly and enter delay shooting status.
4. After the count down is done, the Receiver will output one shooting signal every one second to control camera to shoot according to the number of shots.
 5. Before the count down is done, repress release button or any buttons on the Receiver will end this time delay schedule operation.
 - Please set camera function setting as []
 - When camera function setting is [], it may shoot continuously.
 - When camera function setting is [**BULB**], camera will shoot with Bulb function. It may cause underexposure or overexposure.
 - When camera function setting is [], camera will perform one time or many times delay shooting.
 - When camera lens focus function set as [**M**], half-press the release button of the Transmitter, the camera will not perform focus operation.
 - When camera lens focus function set as [**AF**], most cameras will not perform shooting operation if they cannot find focus point, even they received shooting signal.



Timer Schedule Shooting



◆ Timer Schedule Shooting Diagram

1. When power is ON, move Transmitter function icon to timer schedule shooting function by pressing shift left button [] or shift right button [].
2. Press SET button to enter corresponding setting.
3. Gently press [] button once, setting value will be added one, press and hold this button, the setting value will be added quickly; Gently press [] once, setting value will be reduced one, press and hold this button, setting value will be reduced quickly.
 - Under timer schedule shooting, [**N1**] can set 1-99 pictures, repeat shooting times [**N2**] can set 1-99 pictures, and “__” can set unlimited times.

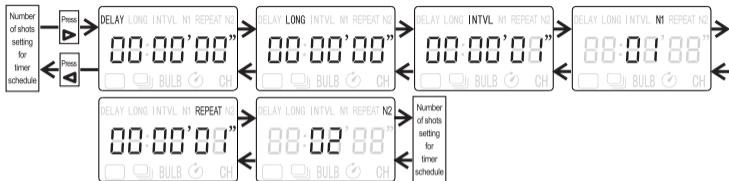
- If you don't need to repeat timer schedule shooting, please set the repeat interval shooting time and repeat shooting times as 1.



◆ Perform Timer Schedule

1. Move Transmitter function icon to any timer schedule icons by pressing shift left button [◀] or shift right button [▶].
2. Press timer schedule start/stop button []. The Transmitter will send all information to the Receiver. At this time, the green LED light indicator on the Receiver will quick blink twice every 2 seconds. It means the Receiver received the full information and runs properly. Timer schedule will perform on the Receiver and output control signal to camera.
3. The Transmitter LCD screen will display timer schedule status, but it won't send control command to the Receiver. It only for you to know the running status of the Receiver.
 - Before the timer schedule is completed, repress the Transmitter timer schedule start/stop button [], then the Transmitter and Receiver will stop performing timer schedule.
 - When the Receiver is performing timer schedule, press any buttons on the Receiver will end this time timer schedule operation.



Below is the example to show the operation of timer schedule shooting: Delay time [DELAY] =5 sec, exposure time [LONG] =1 sec, shooting interval [INTVL] =5 sec, shooting numbers [N1] =2, repeat interval time [REPEAT] =5sec,repeat times [N2] =2 times.

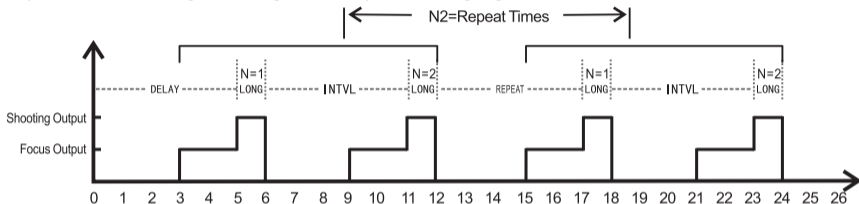

TW-283 Specifications

Type: FSK 2.4GHz wireless control system

Channel: 30 channels

Stand-by Time:

Transmitter: over 1000 hours

Dimension((L×W×H):146X400mmx19mm

Weight:

Transmitter:52.6g(excluding batteries)

Transmission Distance: over 80M

Receiver: 400 hours

Receiver:73mmX38mmX31mm

Receiver:36.2g(excluding batteries)

Now you may use this high-performance wireless timer remote control TW-283. If you have any questions, please contact your local dealer or visit <http://www.pixelhk.com>.



無線定時快門綫

TW-283



使用手冊

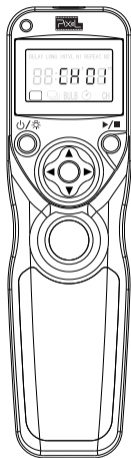

總述



感謝您購買高性能的品色產品

首先,非常感謝您購買高性能的無線定時器TW-283,它擁有簡易的單張拍攝、1秒連拍、B門拍攝、延時拍攝以及定時計劃拍攝。低功耗的液晶顯示屏,能讓您的使用計劃一目了然,更方便地使用延時拍攝及定時計劃拍攝。

在使用前,您一定要通讀并完全理解本使用說明書以及了解相機的使用方法,以保證您的熟悉操作,并且能正確使用。您可以通過本說明書而輕鬆掌握本產品的使用方法及注意事項。

注意事項

- △ 安裝電池時極性切勿弄反,否則電池可能滲漏腐蝕性液體、發熱或爆炸。
- △ 在安裝接收器(TW-283RX)前,請確認相機和接收器是關機狀態。
- △ 電纜綫與設備連接時,請勿拉扯。
- △ 本產品屬電子產品的附件,有可能因外界環境因素影響而造成相機不能或異常動作,這種情況的可能性非常小。
- △ 不要使產品受到強烈振動,否則可能引起產品故障。
- △ 長時間不使用產品時,請將電池取出,以防電池滲漏腐蝕性液體而損壞產品。
- △ 請勿將產品置于高溫中,如陽光直射下的封閉空間等高温地方。
- △ 請保持乾燥,切勿用濕手接觸產品,亦不可將產品侵入水中或暴露雨中,否則可能引起產品無法正常使用。
- △ 請勿在易燃易爆環境中使用本產品,違反此警告可能引起火災或爆炸。
- △ 本產品涉及電池,關於電池的使用請嚴格按照相應的操作規範和注意事項,否則可能引起火災、爆炸或人身傷害。

TW-283簡介

- 利用無線遙控技術，實現對具備外接快門插座的相機進行遙控操作。
- 採用FSK制式，提高了產品的可靠性和穩定性，使用2.4GHz全球免費無線頻段，30個可選通道。
- 控制距離可達80米以上。
- 使用液晶顯示通道、電量、功能模式、簡單易懂、操作方便。
- 超低功耗待機，傳送器使用AAA電池。
- 可以更換不同型號的快門連接綫控制不同品牌、不同型號的相機。
- 可對相機進行單張拍攝、1秒連拍，B門拍攝、延時拍攝及定時計劃拍攝的操作。
- 設定相關參數進行定時計劃拍攝。



各部位名稱

拆開包裝後請檢查包裝內是否含以下物品，如有缺失請與經銷商聯系。

- | | |
|----------------------------|----------------------------|
| 1、傳送器 (TW-283TX) -----1個 | 2、接收器 (TW-283RX) -----1個 |
| 3、快門連接綫-----1條 | 4、說明書 (本說明書) -----1份 |

下面介紹本產品各部位名稱：

接收器(TW-283RX):

- | | |
|----------------|------------|
| ① 指示燈 | ⑦ 電池艙 |
| ② 電池欠壓圖標 | ⑧ 控制信號輸出接口 |
| ③ 電源按鈕/通道減少按鈕 | ⑨ 快裝板固定螺母 |
| ④ 背光燈按鈕/通道增加按鈕 | ⑩ 熱靴鎖緊螺母 |
| ⑤ 通道顯示屏幕 | ⑪ 熱靴固定腳 |
| ⑥ 電池蓋 | |

傳送器(TW-283TX):

- | | |
|--------------|---------------|
| ① 開/關鍵、背光燈按鈕 | ⑧ 定時計劃啓動/停止按鈕 |
| ② 左移按鈕 | ⑨ 顯示屏 |
| ③ 數字減少按鈕 | ⑩ 指示燈 |
| ④ 釋放按鈕 | ⑪ 電池蓋 |
| ⑤ 設置/確定按鈕 | ⑫ 機身號 |
| ⑥ 右移按鈕 | ⑬ 產品背貼紙 |
| ⑦ 數字增加按鈕 | |

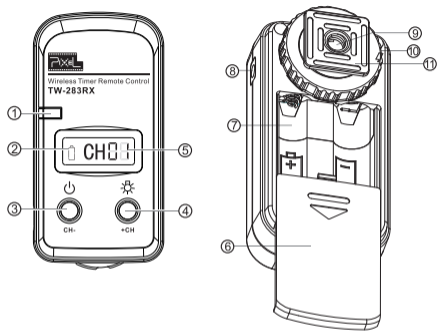

接收器(TW-283RX)

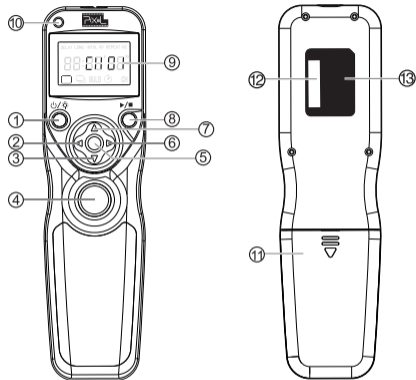

傳送器(TW-283TX)

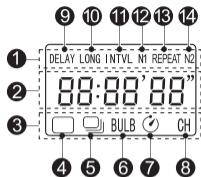

傳送器顯示屏

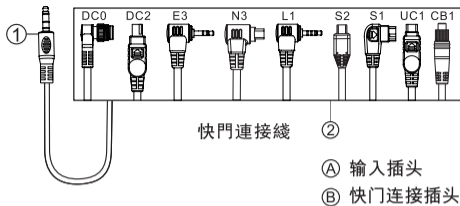

- Ⓐ 輸入插頭
Ⓑ 快門連接插頭

- | | | | |
|-----------|------------|--------------|----------------|
| Ⓐ 定時計劃功能區 | Ⓔ 1秒連拍圖標 | Ⓓ 定時計劃延時圖標 | Ⓐ 重復定時計劃間隔時間圖標 |
| Ⓑ 時間顯示區 | Ⓕ BULB拍攝圖標 | Ⓕ 定時計劃曝光時間圖標 | Ⓑ 重復定時計劃次數圖標 |
| Ⓒ 功能區 | Ⓖ 延時拍攝圖標 | Ⓖ 定時拍攝間隔時間圖標 | |
| Ⓓ 單張拍攝圖標 | Ⓖ 通信通道圖標 | Ⓖ 定時拍攝張數圖標 | |

安裝及使用設備

開始使用前,請您務必認真閱讀相機的使用說明書,并了解相機的操作方法及功能設定。因為相機的功能設定可能會影響到本產品對相機的有效控制。



安裝更換電池

當傳送器電池量不足時，顯示屏上的筆畫明顯變暗或電池欠壓圖標 [] 將閃爍，則表示電池電壓已經降到影響設備工作性能的限度，應盡快更換電池，使用二節AAA電池。

按照電池艙內的正極 [+] 和負極 [-] 標志將電池正確裝入。



TW-283 發射器

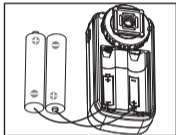

TW-283 接收器

⚠ 安裝電池時應注意電池的極性，錯誤的安裝會使設備無法正常工作，甚至損壞設備及造成人身傷害。



接收器與相機的連接

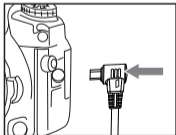
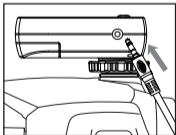

- 1、確認您的接收器已安裝到位，并確保相機及接收器均已關機。
- 2、首先將快門連接綫的輸入插頭插入接收器的控制信號輸出接口，確認接插到位。
 - ▶ 快門連接綫沒有插到位可能會造成定時器無法控制相機。



3、將相機固定于三角架或其它固定支架上。打開相機外接快門插座保護蓋，將連接綫的快門插頭插入相機的外接快門插座，確保接插到位，有鎖緊螺母的需將螺母旋緊。

- 大部分相機的外接快門插座帶有防誤插缺口，進入時請注意插頭方向，以免損壞相機的外接快門插座。

4、打開接收器電源，再打開相機電源。

打開或關閉電源

◆ 傳送器 (TW-283TX)

- 1、開關鍵[/]，按住該按鈕2秒打開或關閉傳送器電源。
- 2、打開電源後，之前設置的定時計劃和通信通道不變。
- 3、傳送器待機時間為30分鐘，30分鐘無任何動作，傳送器自動關閉。

◆ 接收器 (TW-283RX)



傳送器 (TW-283TX)

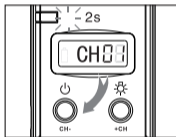

接收器 (TW-283RX)

- 1、按電源按鈕 [] 2秒鐘，打開接收器電源，此時，指示燈每隔2秒閃亮一次綠燈，屏幕顯示通信通道。
- 2、打開電源後，之前設置的通信通道仍然有效。
- 3、接收器電源不會自動關閉，在開機狀態下，按下電源按鈕2秒將關閉接收器電源。

設置通信通道

◆ 設置傳送器 (TW-283TX) 的通信通道

- 1、按左移按鈕 [] 或右移按鈕 []，將傳送器活動功能圖標移至通道圖標 [CH]。

- 按設置/確定按鈕進入通道設置，此時，通道數字閃爍。
- 通過按數字增加按鈕 [▲] 或數字減少按鈕 [▼]，調整通道數字。
- 再次按下設置/確定按鈕，保存當前通道。

◆ 設置接收器 (TW-283RX) 的通信通道

- 打開電源，通信通道默認為上次設定的通道。
- 同時按下 [+CH] 和 [CH-] 按鈕，進入通道設置，顯示屏上的通道圖標 [CH] 閃爍。
- 按 [+CH] 通道增加1、[CH-] 通道減少1。
- 再次同時按下 [+CH] 和 [CH-] 按鈕或10秒無動作保存并退出。

* 傳送器與接收器必須保持相同頻道才能進行有效控制。



傳送器 (TW-283TX)

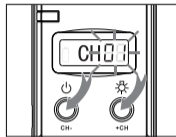

接收器 (TW-283RX)

打開背光燈

◆ 傳送器 (TW-283TX)

輕按[☰/☼]該按鈕可打開顯示器屏背光燈。

◆ 接收器 (TW-283RX)

在開機狀態下，按住背光燈按鈕[☼]2秒鐘後，將打開背光燈。

- 打開背光燈後兩次按鍵操作時間間隔在6秒鐘內，背光燈將一直點亮。
- 背光燈不能手動關閉，在無任何操作6秒鐘後將自動關閉。

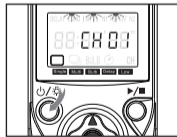

傳送器 (TW-283TX)

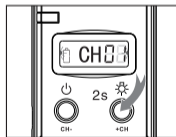

接收器 (TW-283RX)

拍攝控制

拍攝功能選擇示意圖：

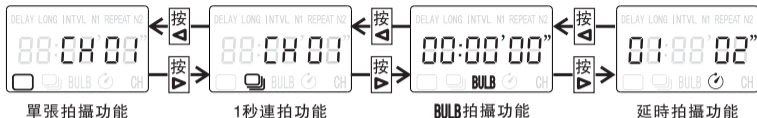

以下的使用介紹接收器與相機已經連接牢固，并打開接收器及相機電源，下面將詳細介紹拍攝功能的使用。



單張拍攝

- 1、在開機狀態下通過按左移按鈕 [◀] 或按右移按鈕 [▶]，將傳送器的活動功能圖標移至單張拍攝圖標 [□]。
- 2、半按釋放按鈕，傳送器發出對焦信號，傳送器和接收器上的綠色指示燈點亮，相機處於對焦狀態，直至鬆開或全部按下。
- 3、全按釋放按鈕，傳送器發出拍攝信號，傳送器和接收器上的紅色指示燈點亮片刻，相機進行拍攝。
 - 應將相機功能設置為 [□]
 - 當相機功能設置為 [📷] 時，可能會出現連續拍攝。
 - 當相機功能設置為 [BULB] 時，相機將以B門功能拍攝，可能造成曝光不足或過曝。
 - 當相機功能設置為 [🕒] 時，相機將會延時拍攝。



連續拍攝

- 1、在關機狀態下通過按左移按鈕 [◀] 或右移按鈕 [▶]，將傳送器的活動功能圖標移至連續拍攝圖標 [📷]。
- 2、半按釋放按鈕，傳送器發出對焦信號，傳送器和接收器上的綠色指示燈點亮，相機處於對焦狀態，直至鬆開或全部按下。
- 3、全按釋放按鈕，傳送器和接收器上的紅色指示燈亮，保持全按釋放按鈕，傳送器將連續發出拍攝信號，傳送器和接收器的紅燈點亮，相機進行連續拍攝動作。
- 4、鬆開釋放按鈕，傳送器停止發送信號，相機停止拍攝。
 - 應將相機功能設置為 [📷]
 - 當相機功能設置為 [📷] 時，可能會出現單次拍攝。
 - 相機功能設置為 [BULB] 時，相機將以B門功能拍攝，可能造成曝光不足或過曝。
 - 當相機功能設置為 [🕒] 時，相機將會執行一次或多次延時拍攝。



BULB 拍攝

- 1、在開機狀態下通過按左移按鈕 [◀] 或右移按鈕 [▶]，將傳送器的活動功能圖標移至B門拍攝圖標 [BULB]。
- 2、半按釋放按鈕，傳送器發出對焦信號，傳送器和接收器的綠色指示燈點亮，相機處於對焦狀態，直至鬆開或全部按下。
- 3、全按釋放按鈕，傳送器發出B門開始信號，傳送器紅燈開始閃爍並且計時開始，接收器上的紅燈保持點亮，接收器連續輸出拍攝信號，相機開始連續曝光拍攝。

4、再次按下釋放按鈕，傳送器輸出B門拍攝停止信號，并顯示曝光時間相機停止曝光拍攝。

- ▶ 應將相機功能設置為 [BULB]
- ▶ 當相機功能設置為 [] 時，相機祇拍攝一次而不會進行B門拍攝。
- ▶ 當相機功能設置為 [] 時，相機將會進行連續拍攝。
- ▶ 當相機功能設置為 [] 時，相機將會延時拍攝一次。



延時拍攝

TW-283的延時拍攝功能是自定義延時時間和拍攝張數的。

◆ 延時拍攝的設置



- 1、在開機狀態下通過按左移按鈕 [◀] 或按右移按鈕 [▶]，將傳送器活動功能圖標移至延時拍攝圖標 []。按設置按鈕進入延時拍攝的拍攝時間設置。拍攝時間值 [02] 閃爍，按 [▲]，設置可延時時間增加，按 [▼] 鍵，設置延時時間減少，可設置延時時間1-59秒。



- 2、按 [◀] 鍵，進入延時拍攝張數設置，此時拍攝張數 [01] 閃爍，按 [▲]，設置拍攝數量增加，按 [▼] 鍵，設置拍攝數量減少，可設置拍攝張數1-99張。
- 3、設置完參數後，按設置按鈕，保存參數并退出設置。

- 進入延時拍攝的設置時，傳送器將保存上一次的設置參數。
- 可以通過按左移按鈕 [◀] 或按右移按鈕 [▶]，轉換拍攝張數和延時時間的設置。
- 輕按 [▲] 鍵一次，設置數值增加一，按住不放，設置數值快速增加；輕按 [▼] 鍵一次，設置數值減少一，按住不放，設置數值快速減少。

◆ 延時拍攝的操作

- 1、按左移按鈕 [◀] 或右移按鈕 [▶]，將傳送器活動圖標移至延時圖標 [⌚]。
- 2、半按釋放按鈕，傳送器發出對焦信號，傳送器和接收器上的綠色指示燈點亮，相機處於對焦狀態，直至鬆開或全部按下。
- 3、全按釋放按鈕，傳送器將全部拍攝信息發送到接收器，傳送器開始延時倒計時，接收器紅色指示燈快閃并進入延時拍攝狀態。
- 4、倒計時完畢，接收器將按設置的拍攝張數每秒輸出一個拍攝信號控制相機拍攝。
- 5、延時計劃未完成之前再次按下發射器釋放按鈕或接收器任何按鍵將終止本次延時拍攝操作。
 - 應將相機功能設置為 [□]。
 - 當相機功能設置為 [📷] 時，可能會出現多次連續拍攝。
 - 當相機功能設置為 [BULB] 時，相機每秒以B門功能拍攝，可能造成曝光不足或過曝。
 - 當相機功能設置為 [⌚] 時，相機將會執行一次或多次延時拍攝。
 - 當相機鏡頭對焦功能設置為 [M] 時，半按傳送器釋放按鈕，相機將不進行對焦動作。
 - 當相機鏡頭對焦功能設置為 [AF] 時，大部分相機在沒有找到拍攝焦點時，即使收到拍攝信號也不會進行拍攝動作。



定時計劃拍攝

◇ 定時計劃拍攝示意圖

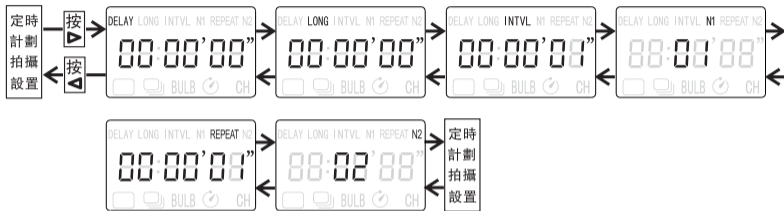

- 1、在開機狀態下通過按左移按鈕 [◀] 或右移按鈕 [▶] ,將傳送器的活動功能圖標移至需要設置定時計劃功能處。
- 2、按設置按鈕，進入相應的設置。
- 3、輕按 [Δ] 鍵一下數值增加一,按住不放,設置參數快速增加,輕按[▽]鍵一下，設置數值減少一，按住不放，設置數值快速減少。
 - 定時計劃拍攝中的 [N1] 可以設置1-99張，重複拍攝次數 [N2] 可以設置1-99張，其中設置為"--"時為無限次數。
 - 如果不再重複定時計劃拍攝，將重複間隔拍攝時間和重複拍攝次數設置為1即可。

◆ 運行定時計劃



1、按左移按鈕 [◀] 或右移按鈕 [▶]，將傳送器的活動功能圖標移至定時計劃圖標區的任意圖標

- 2、按定時計劃啟動/停止按鈕 [▶]，傳送器將所有信息發送至接收器。此時接收器綠燈每隔兩秒快閃2次，表示接收器接收到完整信息并正確運行。定時計劃將在接收器中運行，并對相機輸出控制信號。
- 3、傳送器顯示屏將顯示定時計劃的運行情況，但不對接收器發送控制命令，祇供參考了解接收器的運行情況。
 - ▶ 在定時計劃未運行完畢之前再次按下傳送器定時計劃啟動/停止按鈕 [▶]，傳送器和接收器停止定時計劃的運行。
 - ▶ 接收器在運行定時計劃時，按下接收器任何鍵鍵終止本次定時計劃的運行。

下面將事例說明定時計劃的運行：延時時間 [DELAY] =5秒，曝光時間 [LONG] =1秒，拍攝間隔 [INTVL] =5秒，拍攝張數 [N1] =2張，重復間隔時間 [REPEAT] =5秒，重復次數 [N2] =2次。

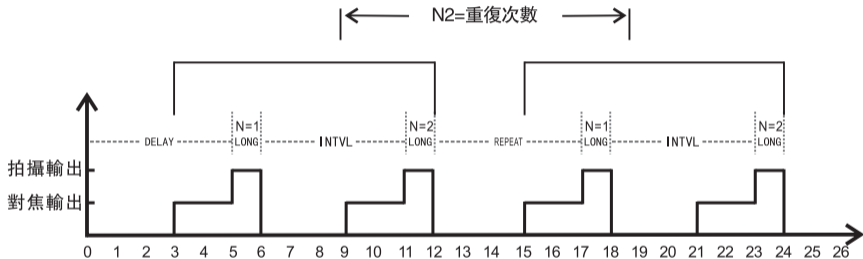



TW-283規格

類型:	使用FSK2.4GHz無線遙控系統	體積 (寬x高x深)
通道:	30個通道	傳送器: 146mmx40mmx19mm
傳送距離:	80米以上	接收器: 73mmx38mmx31mm
待機時間		重量 (不含電池)
傳送器: 1000小時以上		傳送器: 52.6克
接收器: 400小時		接收器: 36.2克

現在，您可以開始使用無與倫比的高性能無線定時器TW-283，如有任何疑問可以向當地經銷商聯系。

或登錄<http://www.pixelhk.com.cn>